



SOD-123 Plastic-Encapsulate Diodes

BZT52B2V4-BZT52B75 ZENER DIODE

FEATURE

- Planar Die Construction
- 0.5W Power Dissipation on Ceramic PCB
- General Purpose, Medium Current
- Ideally Suited for Automated Assembly Processes
- Available in Lead Free Version

PINNING

PIN	DESCRIPTION
1	Cathode
2	Anode

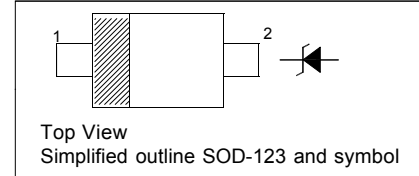

Maximum Ratings(Ta=25°C unless otherwise specified)

Characteristic	Symbol	Value	Unit
Forward Voltage @ I _F = 10mA	V _F	0.9	V
Power Dissipation	P _d	500	mW
Thermal Resistance from Junction to Ambient	R _{θJA}	250	°C/W
Junction Temperature (Note 1)	T _j	150	°C
Storage Temperature Range	T _{stg}	-55 ~ +150	°C

Notes:1. Valid provided that electrodes are kept at ambient temperature

Zener I vs. V Characteristics

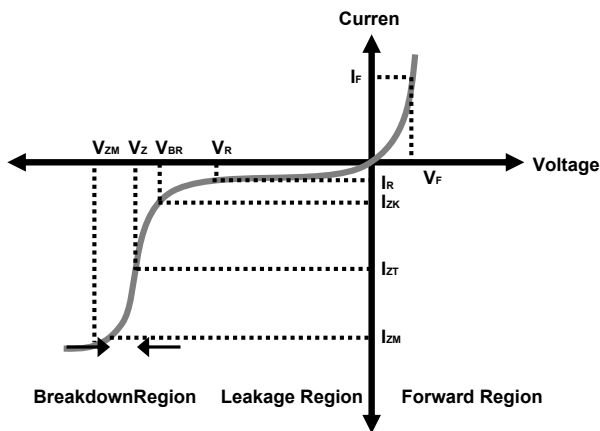

- V_{BR} : Voltage at I_{ZK}
- I_{ZK} : Test current for voltage V_{BR}
- Z_{ZK} : Dynamic impedance at I_{ZK}
- I_{ZT} : Test current for voltage V_Z
- V_Z : Voltage at current I_{ZT}
- Z_{ZT} : Dynamic impedance at I_{ZT}
- I_{ZM} : Maximum steady state current
- V_{ZM} : Voltage at I_{ZM}



Electrical Characteristics(T a = 25°C unless otherwise specified)

Type Number	Type Code	Zener Voltage Range				Maximum Zener Impedance			Maximum Reverse Current	
		V _Z @I _{ZT}			I _{ZT}	Z _{ZT} @I _{ZT}	Z _{ZK} @I _{ZK}	I _{ZK}	I _R	V _R
		Nom.(V)	Min.	Max.	mA	Ω		mA	μA	V
BZT52B2V4	2WX	2.4	2.35	2.45	5	100	600	1.0	50	1.0
BZT52B2V7	2W1	2.7	2.65	2.75	5	100	600	1.0	20	1.0
BZT52B3V0	2W2	3.0	2.94	3.06	5	95	600	1.0	10	1.0
BZT52B3V3	2W3	3.3	3.23	3.37	5	95	600	1.0	5	1.0
BZT52B3V6	2W4	3.6	3.53	3.67	5	90	600	1.0	5	1.0
BZT52B3V9	2W5	3.9	3.82	3.98	5	90	600	1.0	3	1.0
BZT52B4V3	2W6	4.3	4.21	4.39	5	90	600	1.0	3	1.0
BZT52B4V7	2W7	4.7	4.61	4.79	5	80	500	1.0	3	2.0
BZT52B5V1	2W8	5.1	5.00	5.20	5	60	480	1.0	2	2.0
BZT52B5V6	2W9	5.6	5.49	5.71	5	40	400	1.0	1	2.0
BZT52B6V2	2WA	6.2	6.08	6.32	5	10	150	1.0	3	4.0
BZT52B6V8	2WB	6.8	6.66	6.94	5	15	80	1.0	2	4.0
BZT52B7V5	2WC	7.5	7.35	7.65	5	15	80	1.0	1	5.0
BZT52B8V2	2WD	8.2	8.04	8.36	5	15	80	1.0	0.7	5.0
BZT52B9V1	2WE	9.1	8.92	9.28	5	15	100	1.0	0.5	6.0
BZT52B10	2WF	10	9.8	10.20	5	20	150	1.0	0.2	7.0
BZT52B11	2WG	11	10.78	11.22	5	20	150	1.0	0.1	8.0
BZT52B12	2WH	12	11.76	12.24	5	25	150	1.0	0.1	8.0
BZT52B13	2WI	13	12.74	13.26	5	30	170	1.0	0.1	8.0
BZT52B15	2WJ	15	14.70	15.30	5	30	200	1.0	0.1	10.5
BZT52B16	2WK	16	15.68	16.32	5	40	200	1.0	0.1	11.2
BZT52B18	2WL	18	17.64	18.36	5	45	225	1.0	0.1	12.6
BZT52B20	2WM	20	19.60	20.40	5	55	225	1.0	0.1	14.0
BZT52B22	2WN	22	21.56	22.44	5	55	250	1.0	0.1	15.4
BZT52B24	2WO	24	23.52	24.48	5	70	250	1.0	0.1	16.8
BZT52B27	2WP	27	26.46	27.54	2	80	300	0.5	0.1	18.9
BZT52B30	2WQ	30	29.40	30.60	2	80	300	0.5	0.1	21.0
BZT52B33	2WR	33	32.34	33.66	2	80	325	0.5	0.1	23.1
BZT52B36	2WS	36	35.28	36.72	2	90	350	0.5	0.1	25.2
BZT52B39	2WT	39	38.22	39.78	2	130	350	0.5	0.1	27.3
BZT52B43	2WU	43	41.16	42.84	2	150	353	0.5	0.1	30.1
BZT52B47	2WV	47	46.06	47.94	2	170	353	0.5	0.1	33.0
BZT52B51	2X1	51	49.98	52.02	2	180	376	0.5	0.1	35.7
BZT52B56	2X2	56	54.88	57.12	2	200	400	0.5	0.1	39.2
BZT52B62	2X3	62	60.76	63.24	2	215	423	0.5	0.1	43.4
BZT52B68	2X4	68	66.64	69.36	2	240	447	0.5	0.1	47.6
BZT52B75	2X5	75	73.05	76.50	2	255	470	0.5	0.1	52.5

Notes:

1. The Zener Voltage (V_Z) is tested under pulse condition of 10ms.
2. The device numbers listed have a standard tolerance on the nominal zener voltage of **±2%**
3. The zener impedance is derived from the 60-cycle ac voltage, which results when an ac current having an rms value equal to 10% of the DC zener current (I_{ZT} or I_{ZK}) is superimposed to I_{ZT} or I_{ZK}.



FIG 1 Typical Forward Characteristics

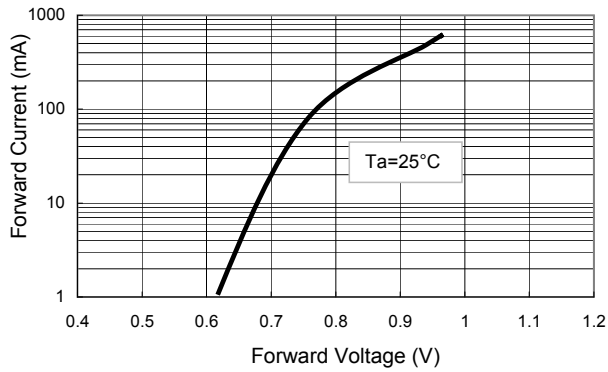

FIG 2 Zener Breakdown Characteristics

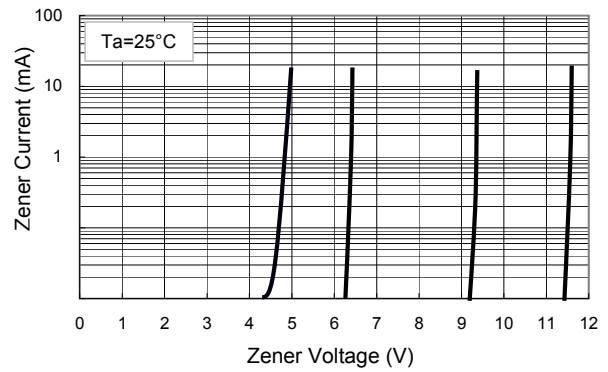

FIG 3 Zener Breakdown Characteristics

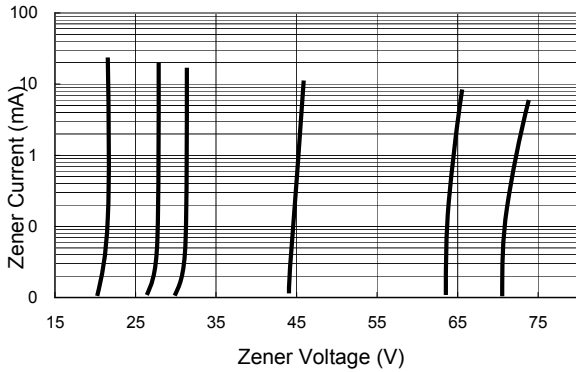

FIG 4 Admissible Power Dissipation Curve

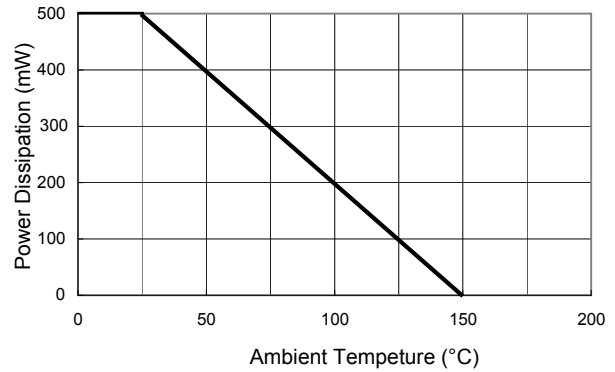

FIG 5 Typical Capacitance

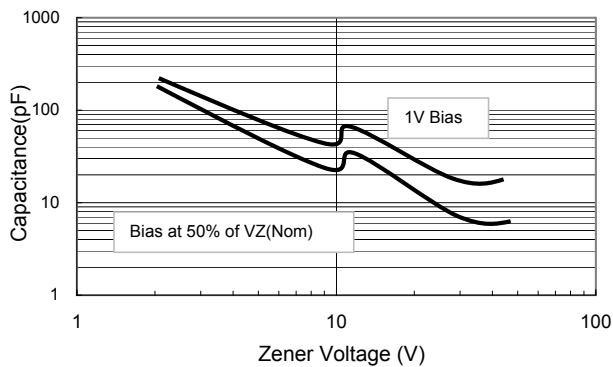
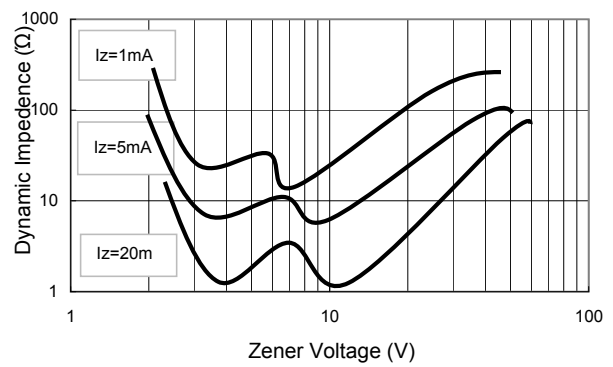
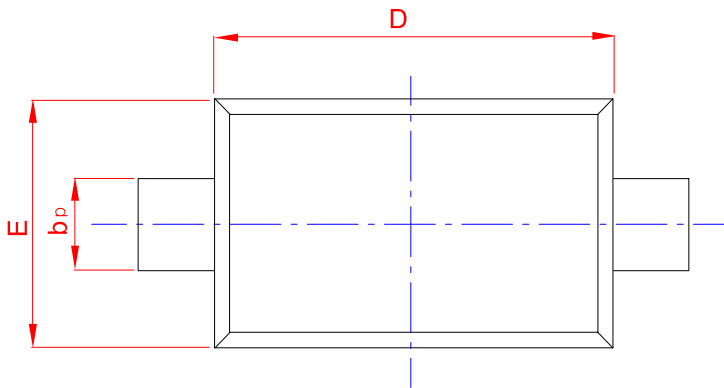
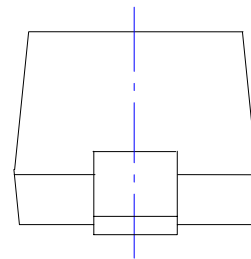
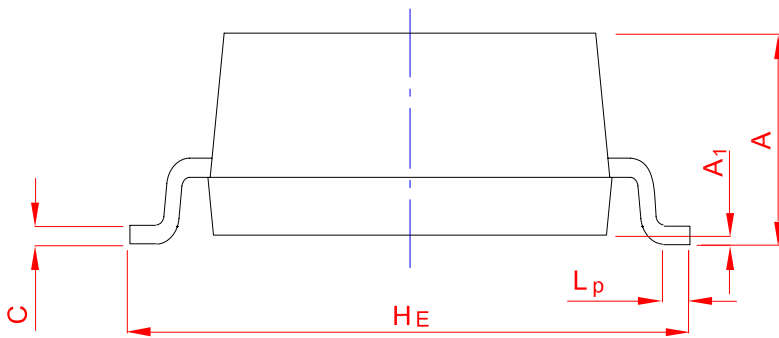
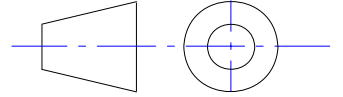

FIG 6 Effect of Zener Voltage on Impedance





PACKAGE OUTLINE SOD-123



UNIT	A	bp	C	D	E	HE	A1	Lp
mm	1.20	0.60	0.135	2.75	1.65	3.85	0.10	0.50
	0.90	0.50	0.100	2.55	1.55	3.55	0.01	0.20